

OUTDOOR program



CLADDING installation guide

Before your start

Prior to installing any composite cladding system, it is recommended that you check with local building codes for any special requirements or restrictions. The diagrams and instructions outlined in this guide are for illustration purposes only and are not meant or implied to replace a licensed professional. Any construction or use of wood plastic composite (Hereinafter referred to as WPC) product must be in accordance with all local zoning and/or building codes. The consumer assumes all risks and liability associated with the construction and use of this product.

Safety

When dealing with any type of construction project, it is necessary to wear appropriate safety equipment to avoid any risk of injuries. When handling, cutting, and installing, the following safety equipment is recommended but not limited to: gloves, a respiratory protection mask, long sleeves, pants, and safety glasses.

Tools

Standard carpentry tools: Power saws (desktop or portable), powerdrills, electric portable drill, toolkits, level, tape, plumb bob etc.



Environment

A clean, smooth, flat, and strong surface is needed to install WPC products correctly. Please check with local building codes before ever installing any type of wall cladding. If the installation does not occur immediately, WPC products need to be put on a flat surface at all times. Never ever should it be put on a surface that is NOT flat.

Planning

Plan a layout before starting the installation to ensure the best possible looking wall cladding for your project.

Building codes and zoning ordinances generally apply to permanent structures, meaning anything that is anchored to the ground or attached to the house. So nearly every kind of wall cladding requires permits and inspections from a local building department. We recommend drawing out a site plan of your proposed project that you intend to do to minimize errors and make your perfect wall cladding.

Construction

WPC products are NOT intended for use as columns, support posts, beams, joist stringers or other primary loadbearing members. WPC products must be supported by a code-compliant substructure. While WPC products are great for retrofits, they CANNOT be installed on existing cladding boards.

Ventilation

WPC products CANNOT be directly installed onto a flat surface. It must be installed onto a substructure, so there is adequate and unobstructed air flow under the cladding to prevent excessive water absorption. A minimum of 25 mm (1 inch) of continuous net free area under the cladding surface is required for adequate ventilation on all wallcladding, so air can circulate between adjacent members to promote drainage and drying.

Main parts for the instalation

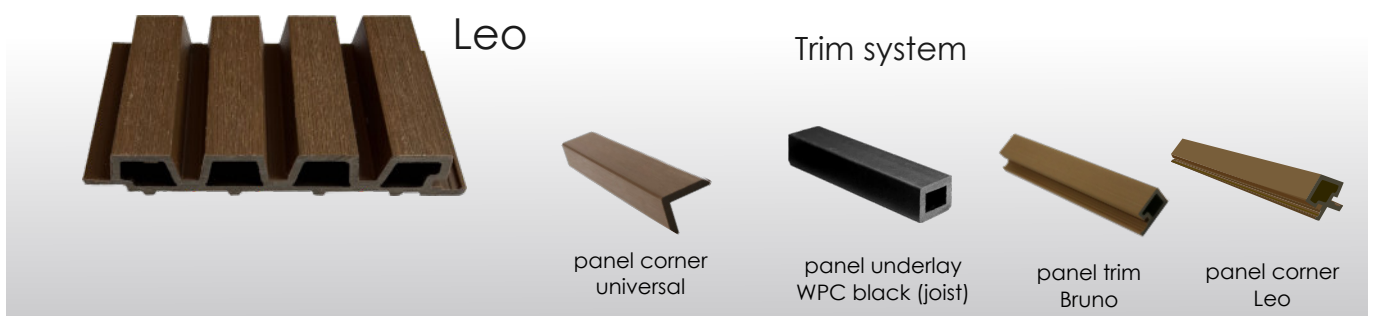
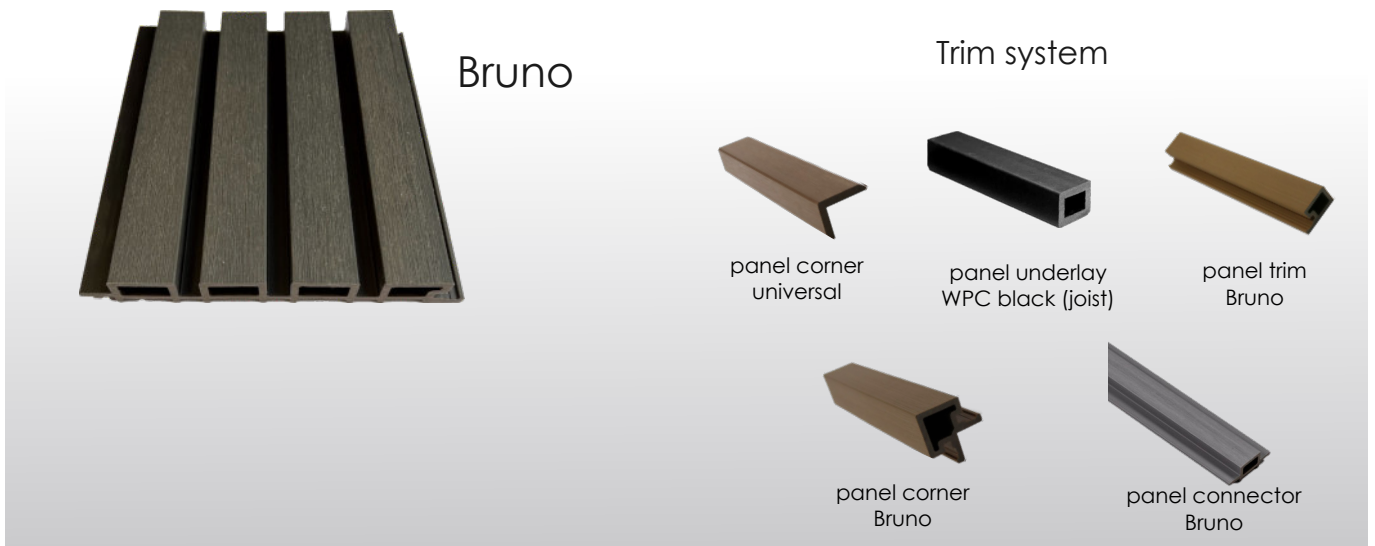
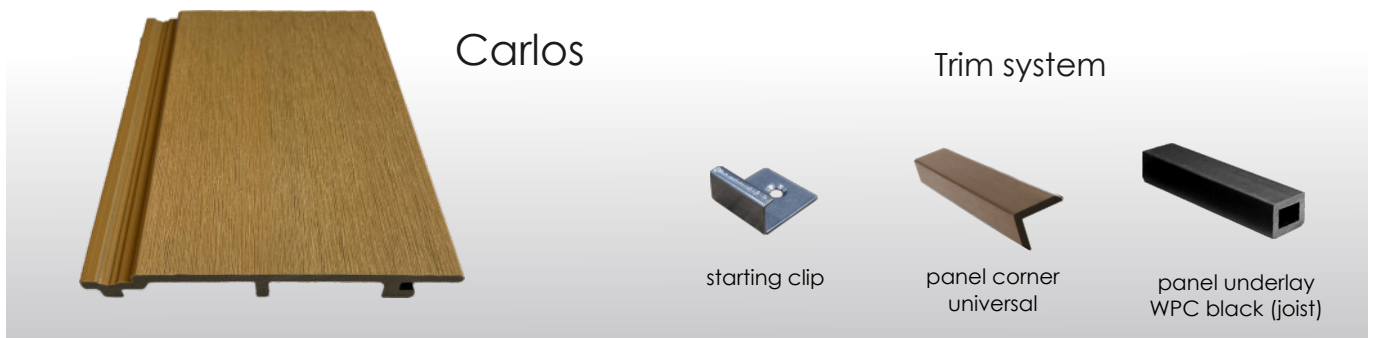

INSTALLATION INSTRUCTIONS

Joist installation

WPC products CANNOT be directly installed onto a flat surface. It must be installed onto a substructure, so there is adequate and unobstructed air flow under the cladding to prevent excessive water absorption. A minimum of 25 mm (1 inch) of continuous net free area under the cladding surface is required for adequate ventilation on all wallcladding, so air can circulate between adjacent members to promote drainage and drying.

1. Before installation, make sure the wall is smooth and solid. It's recommended to use joists made of aluminum or pressure-treated wood.

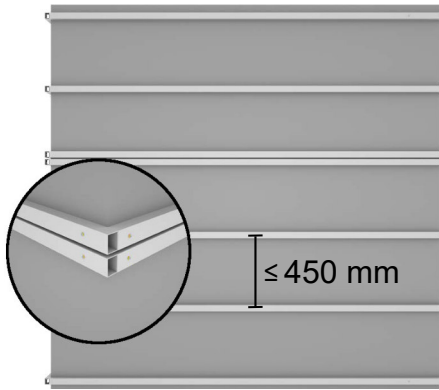
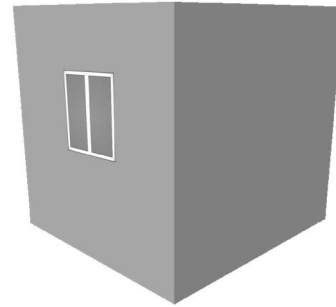

2. Fix joists to the wall with anchors. The spacing between joists on-center should be no more than 450 mm. The spacing between anchors should be 500 mm.

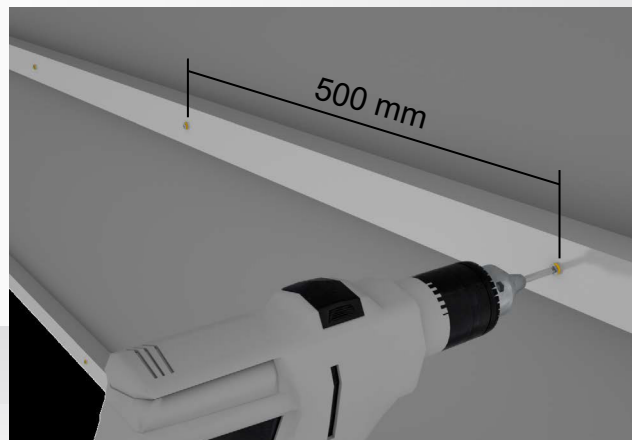

Note: Plan the joist layout with respect to the board length. Double joists are needed at the butt seam between cladding boards, so each board is on its own joist.

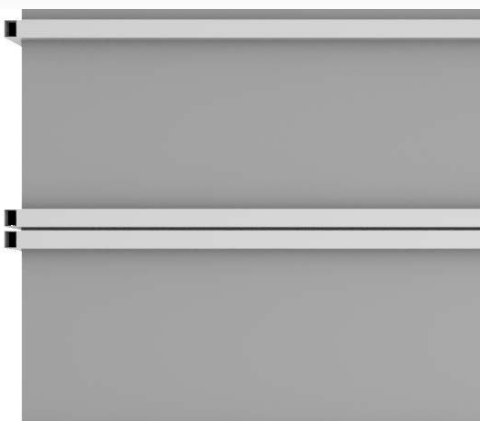

Plastic expansion tubes to fix joist and screw.

INSTALLATION INSTRUCTIONS

Note:

- (1) A minimum gap of 40mm needs to be left between the lowest joist and the floor
- (2) A minimum gap of 10mm needs to be left between the ceiling and the top of the joist

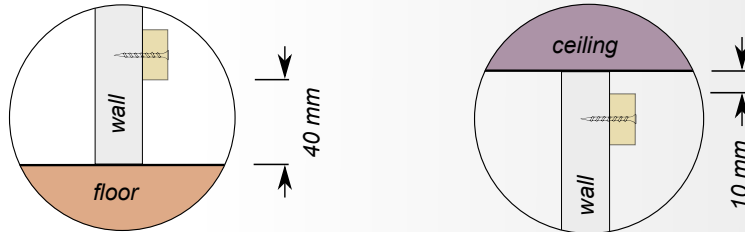

Cladding board installation

1. Put the first piece of wall cladding on the joist, then fix it to the joist with screws. Note that the screws should be installed in the groove of the cladding.

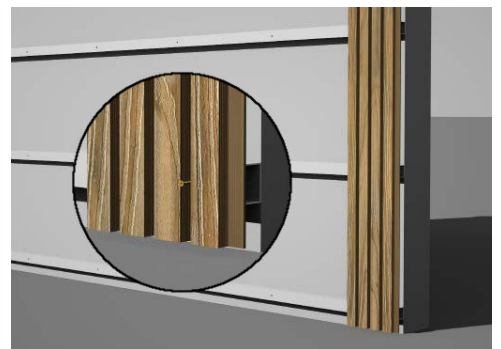

Note: Make sure that there's a gap of at least 10 mm between the cladding and the ground to promote ventilation and offer room for expansion and contraction.

Note:

Always pre-drill a pilot hole before screwing to avoid damage to WPC product!

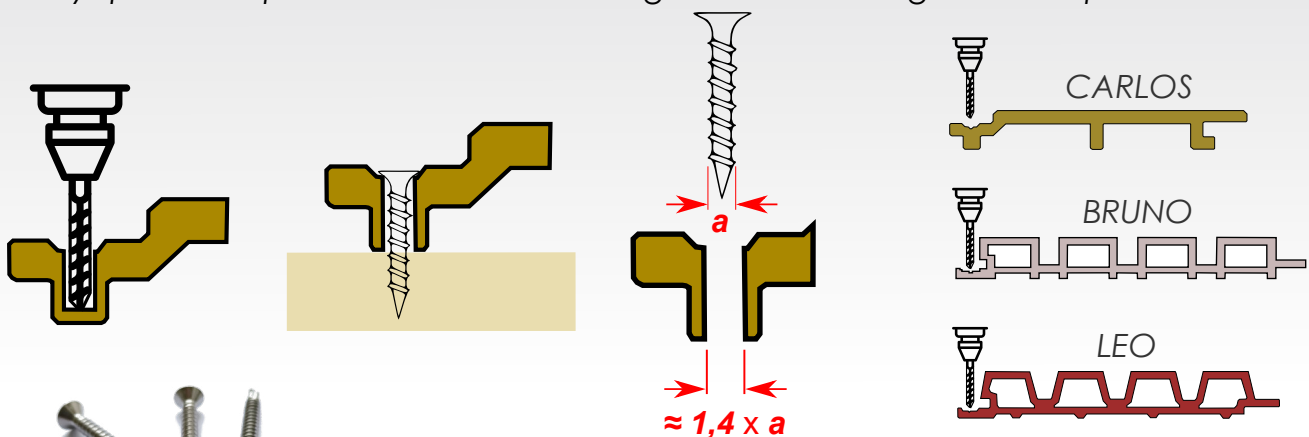

Note: We recommend stainless steel screws 4.2 x 38 mm for fastening the panels. The length must be adapted to the thickness of the joist. The screws are not included in the delivery.

INSTALLATION INSTRUCTIONS

Starting.

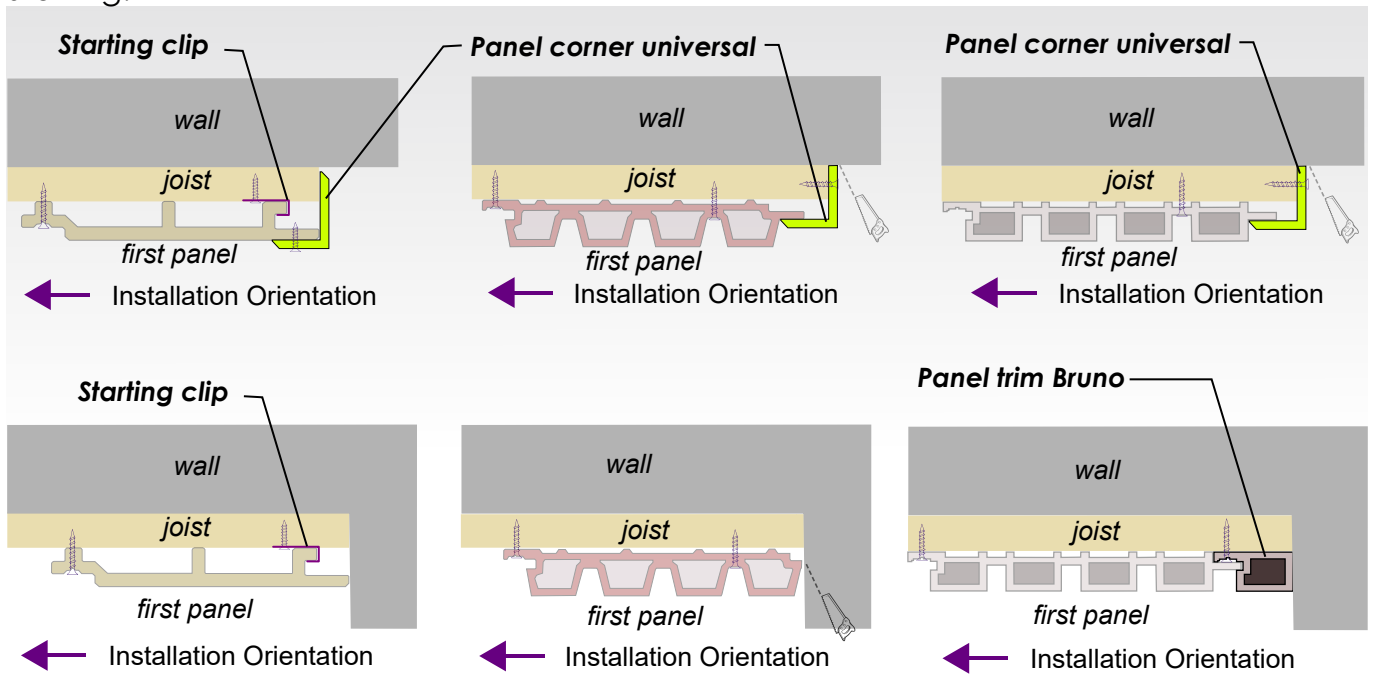

2. Fix the cladding with screws to the joist. The screws should be installed in the screw groove of the cladding.

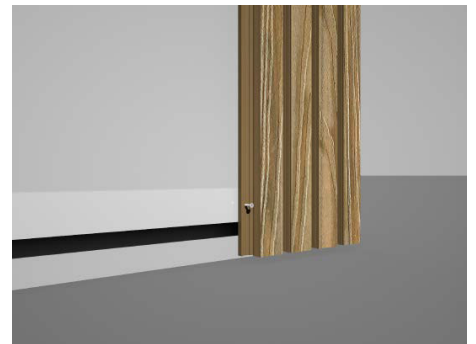

3. Connect the second piece of cladding to the first one. Fix the cladding to the joist with screws. The screws should be installed in the screw groove of the cladding.

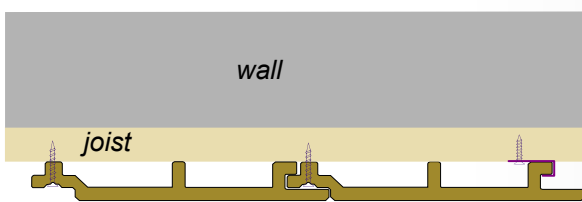
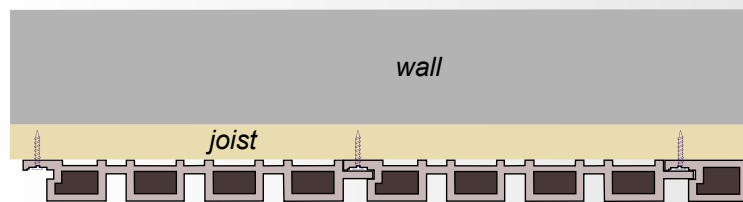
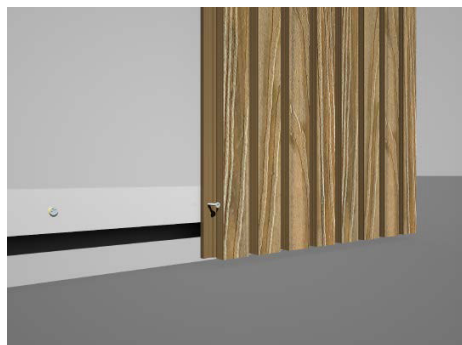

model Carlos

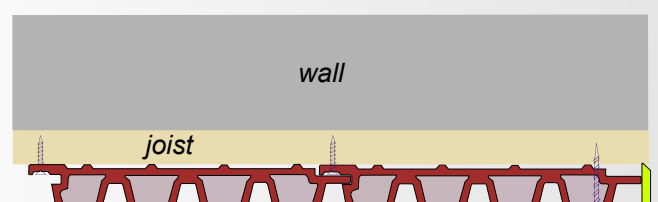

model Leo

INSTALLATION INSTRUCTIONS

4. Continue the installation by repeating step 3.

IMPORTANT: The butt seam between two adjacent cladding boards should be at least 5 mm wide to promote ventilation and offer room for expansion and contraction.

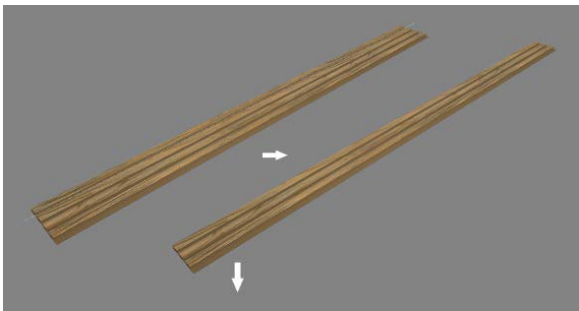
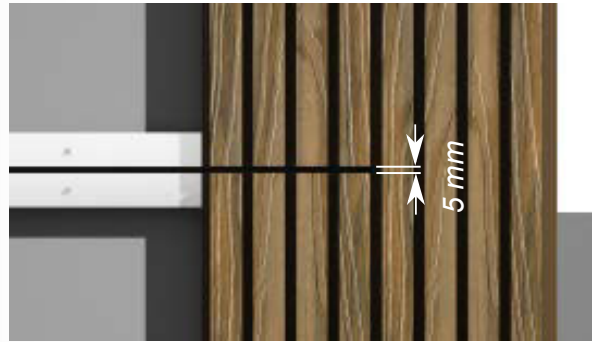

5. When working on the inner corner finish, cut the last cladding board to a suitable width and fix it on the joist with color screws.

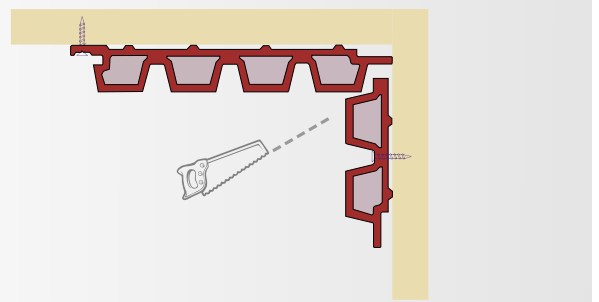
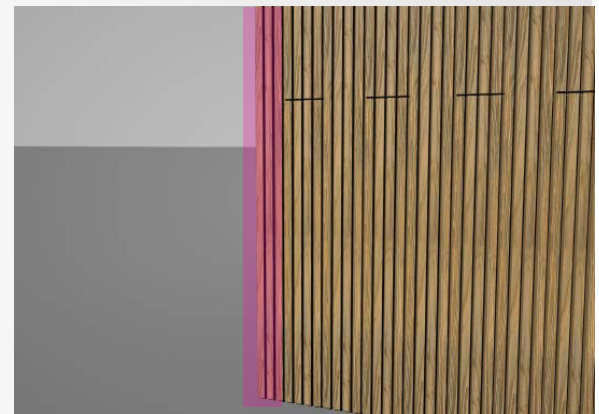
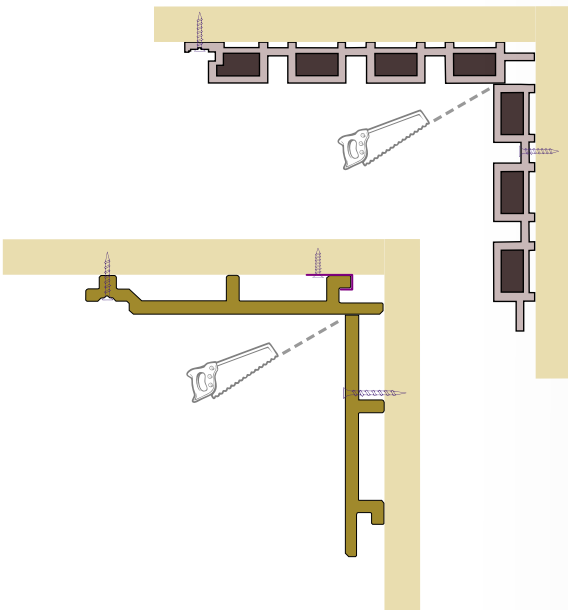

6. Install the cladding boards on the other side. You can use Panel corner Bruno, Panel corner Leo, or Panel corner universal on the outside conner as needed.

Fix the Panel Corner on the joist with screws, then put the second cladding board over the first board, and fix it on the joist with screws again, and so on.

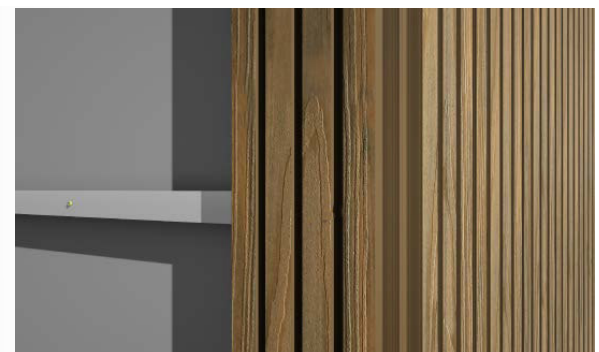

INSTALLATION INSTRUCTIONS

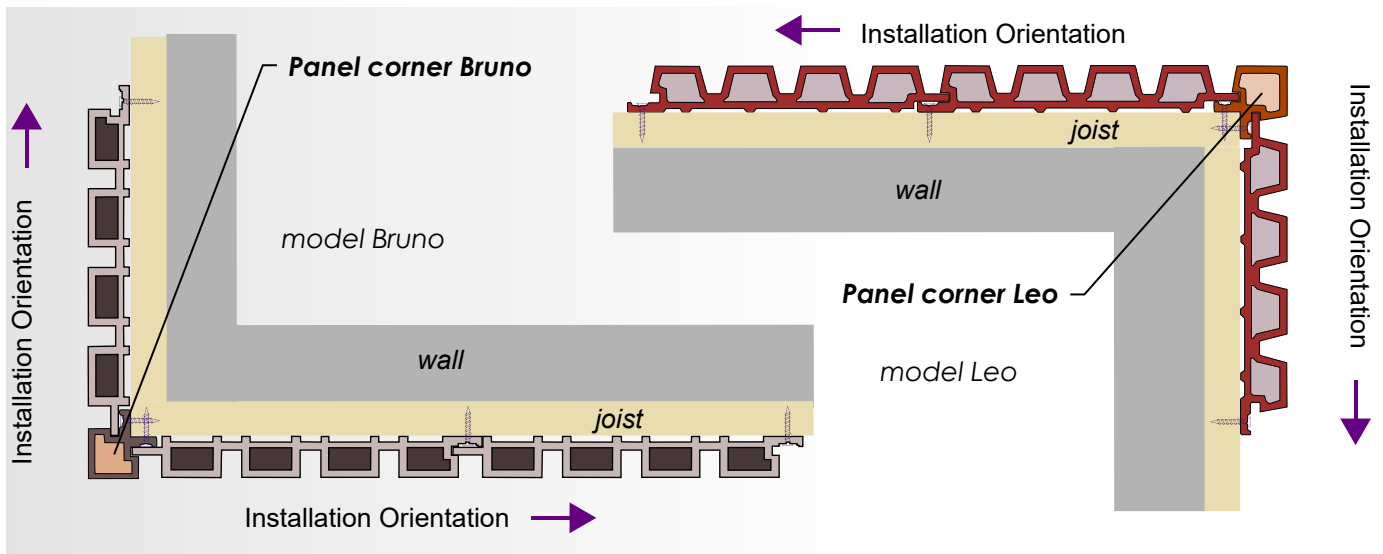

Panel corners universal "L" are installed at vertical corners. Colour head screws should be used fastened through the cladding boards.

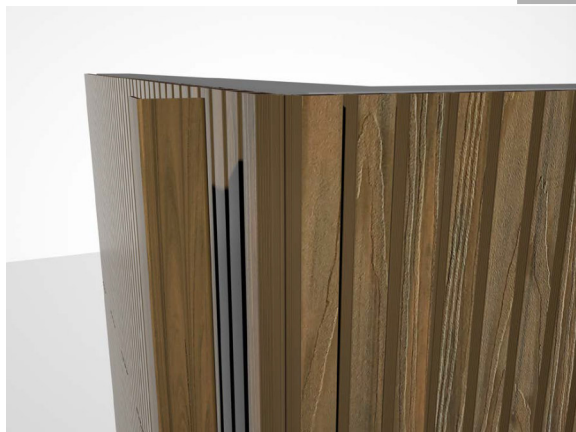
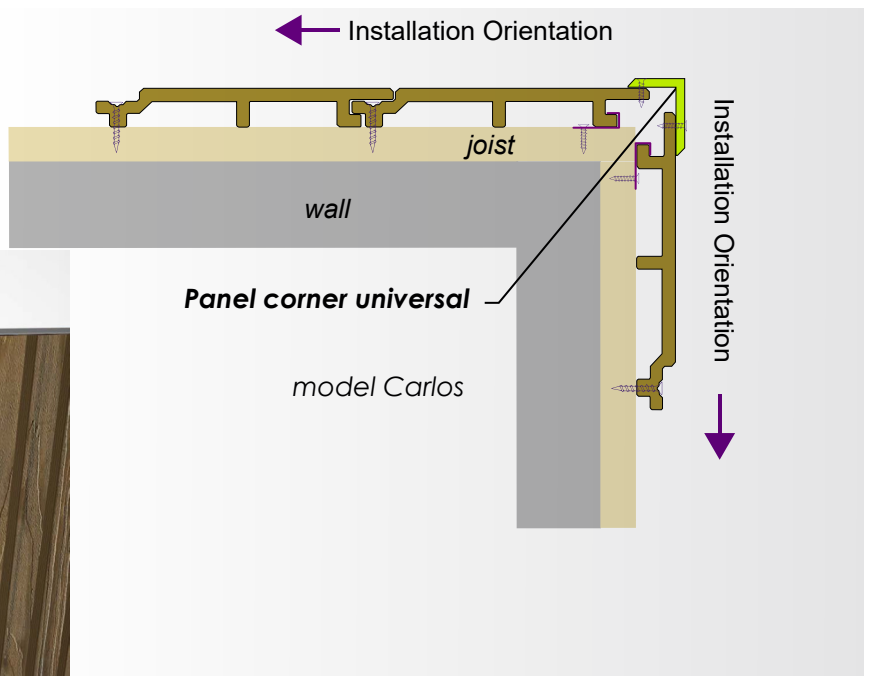

7. If you are installing the last cladding, it ends with the mother groove and needs to be edged, you can use Panel connector Bruno and Panel trim Bruno together.

Carlos and Leo models need to be ends as shown in the pictures below.

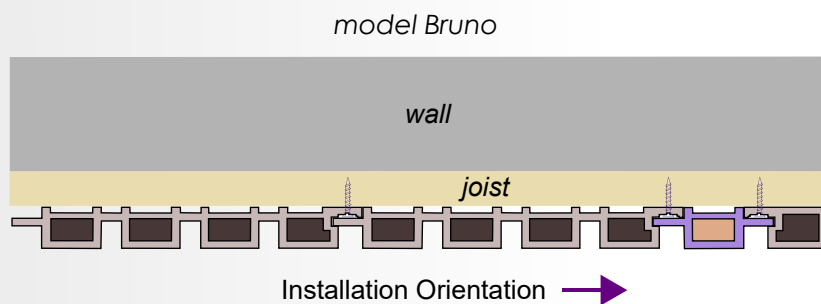

INSTALLATION INSTRUCTIONS

model Carlos

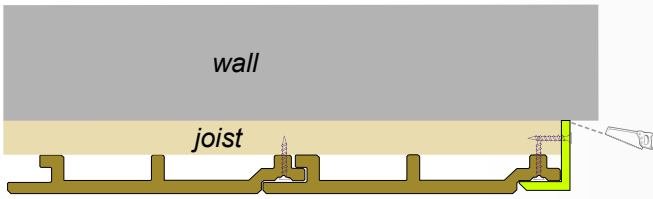

Installation Orientation →

model Leo

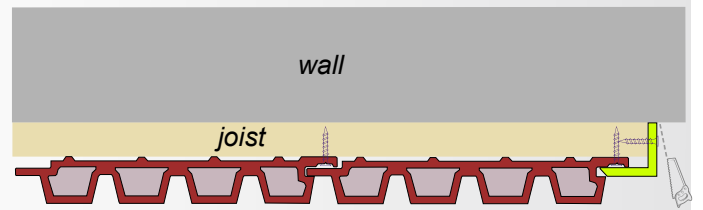

Installation Orientation →



Use colored screws wherever necessary (view part). Coloured stainless steel screws are nearly invisible thanks to their colour (same as boards). Installed in the wave base blend into the facing.

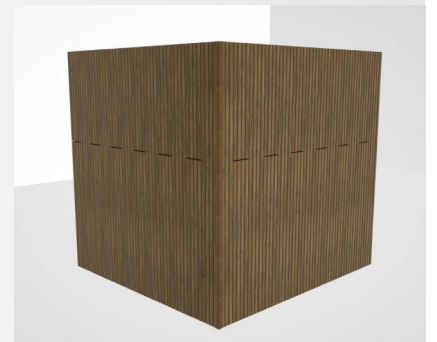

8. Finish the installation

Windows & Doors

1. With respect to the space around the window that's meant to be covered, cut the cladding boards to a suitable length and width, to the point that they are flush with the building opening after being installed.

Note: Make sure there's a gap of at least 8 mm between the window and the cladding boards located above or below the window.

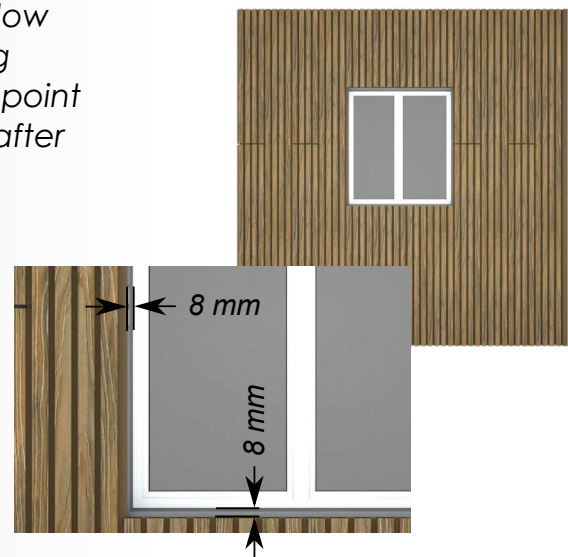

2. With respect to the space around the window that's meant to be covered, cut the window sill boards to a suitable length and width, to the point that they are flush with the cladding boards after being installed.

INSTALLATION INSTRUCTIONS

3. Apply assembly sealant/glue to either the back of the trimmed boards or the area meant to be covered.

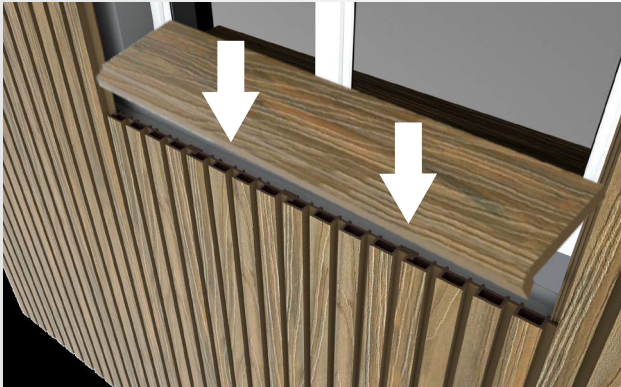

4. For the vertical corners either side of a window or door, L corner should be used. Ensure adjoining window corners are mitre cut for the best finish.



Note.

Allways pre-drill a pilot hole before screwing to avoid damage to WPC product !

INSTALLATION INSTRUCTIONS

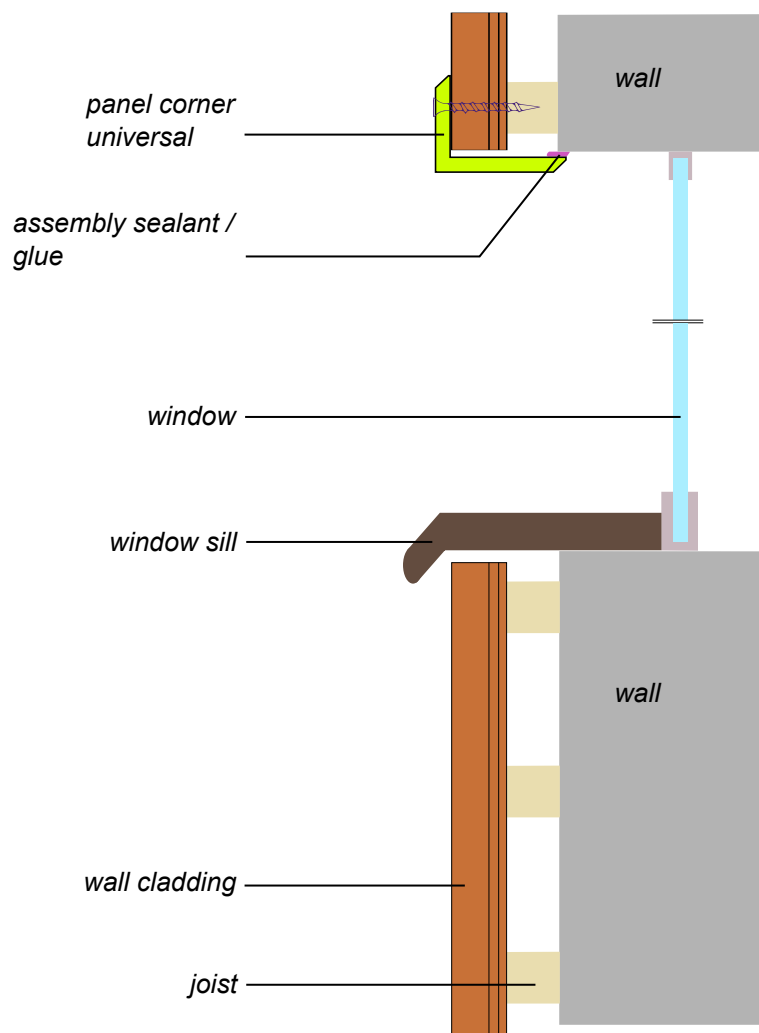

5.FINISH THE INSTALATION

