

OUTDOOR program



CLADDING specification

Composite cladding panels with a polymer shell. This composite wall cladding is beautiful, colorfast, easy to clean and maintain, and is one of the best alternatives to traditional wood exterior cladding. WPC cladding panels are from the second generation of composite wood and use the latest WPC material production technology - **co-extrusion**.

A thin layer of polyethylene shell is applied to the surface of the panel.

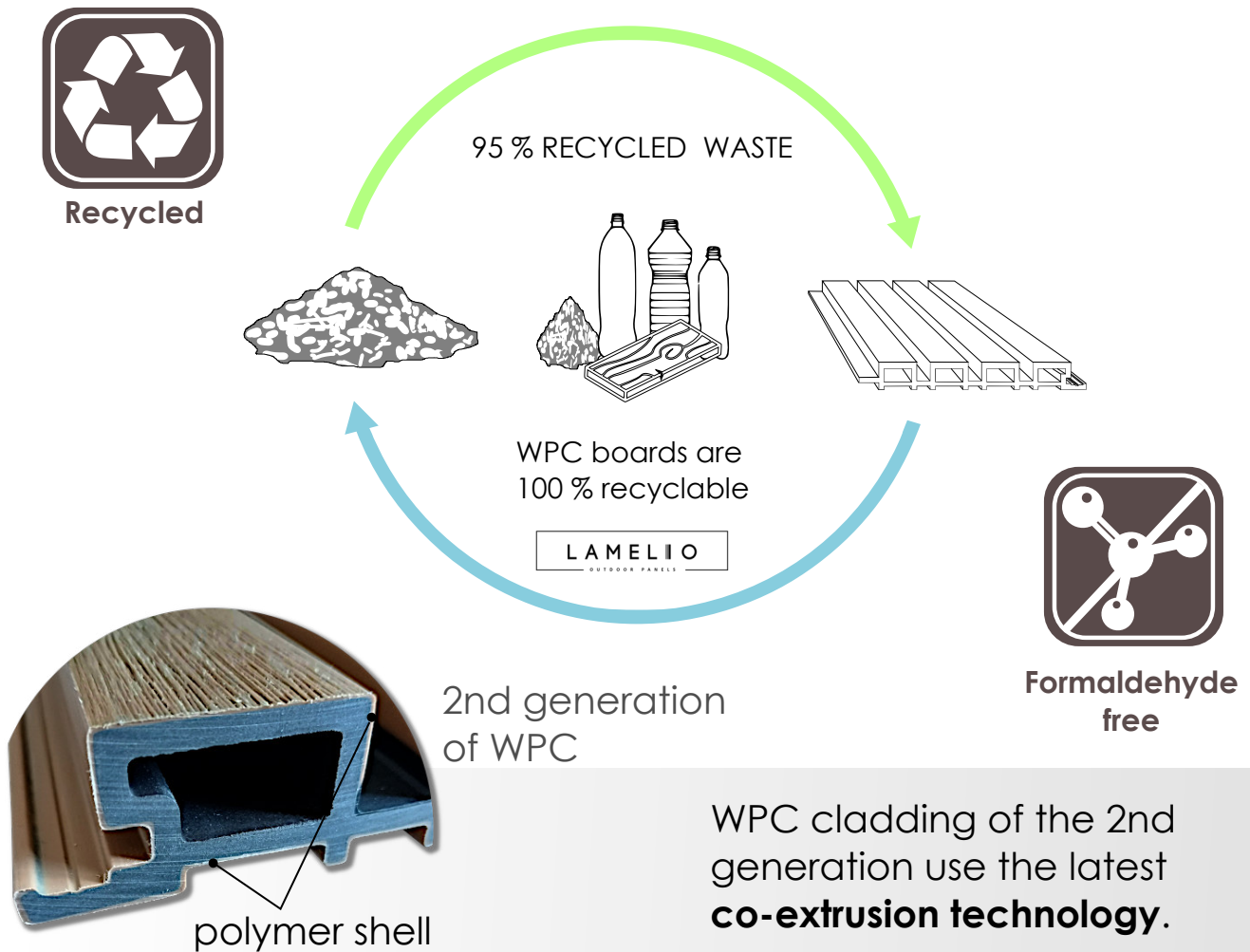

WPC cladding of the 2nd generation use the latest **co-extrusion technology**.

Co-extrusion WPC has a "cover" that provides added protection against the elements and everyday living while the extruded surface is made of multi engineer plastic with an outer shell of plastic that completely encapsulates the board in an impermeable layer of protection from scratches, stain and fading. The shield and core are extruded simultaneously, so there are no adhesives or chemicals that are harmful to the environment.

It combines the advantages of wood and plastic, but reduces the need for repetitive and wasteful maintenance, and decreases the amount of attention and money will needed to spend on repairs.

ECO friendly

WPC is green and eco-friendly with wide applications which can replace wood material (low maintenance cost and having over 15 to 25 years' service life). The products have passed ISO 9000, the quality management system, ISO 14001, the environmental management system and OHSAS18001, the occupational health and safety management system certification. The company's products have obtained FSC certification and passed the REACH test. The products have been tested in ITS and SCS for a long time and passed the corresponding standards.



Unique colors and an interesting surface

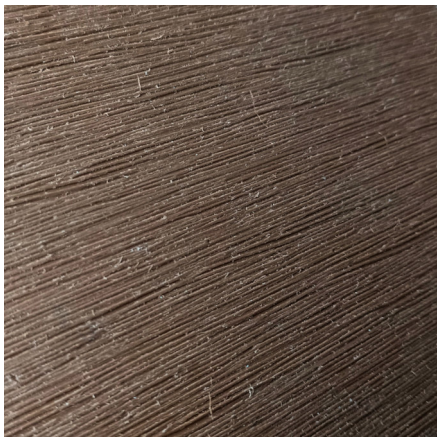

Our panels are characterized by a unique surface that faithfully imitates the surface of wood. We chose the colors so that they reflect the unique character of your buildings.

SILVER
GRAY

TEAK

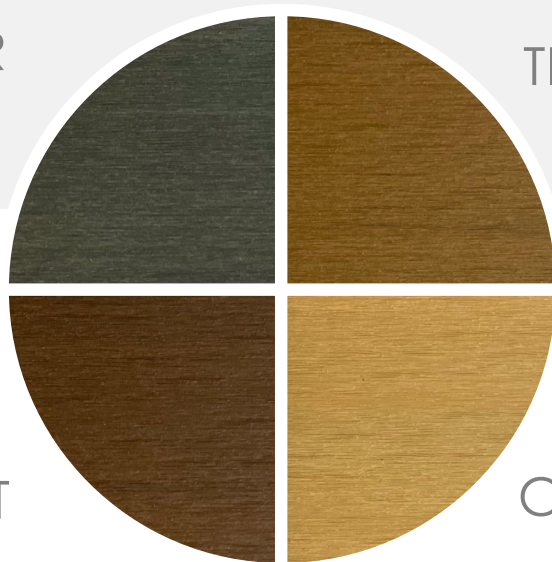

WALNUT

CEDAR

Weather resistant

As a product for outdoor use, we place high demands on the performance of the product. Our wood-plastic products are designed for extreme weather, such as extreme temperatures, high humidity and insect resistance, etc. The surface of our panels is not porous, so small particles and dust do not penetrate into the wood composite.



Weather resistant



Insect resistant



Waterproof

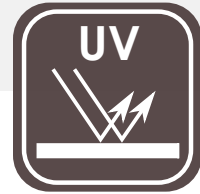

UV resistant

Warranty against Stain and fade

Our products are tested for the influence of the weather, where we achieve excellent results by default. This shell protects the panel from moisture, prevents the formation of stains and also prevents the color from fading.

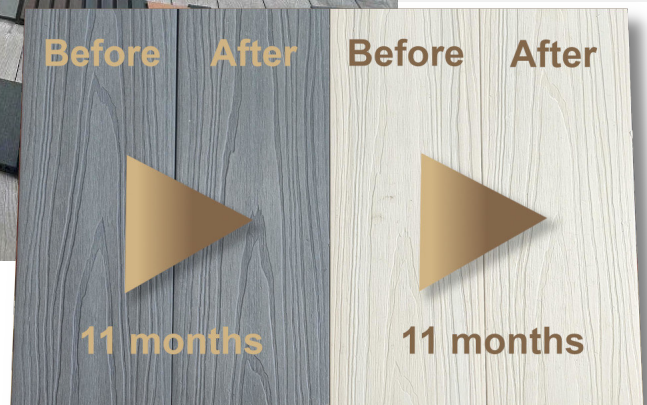
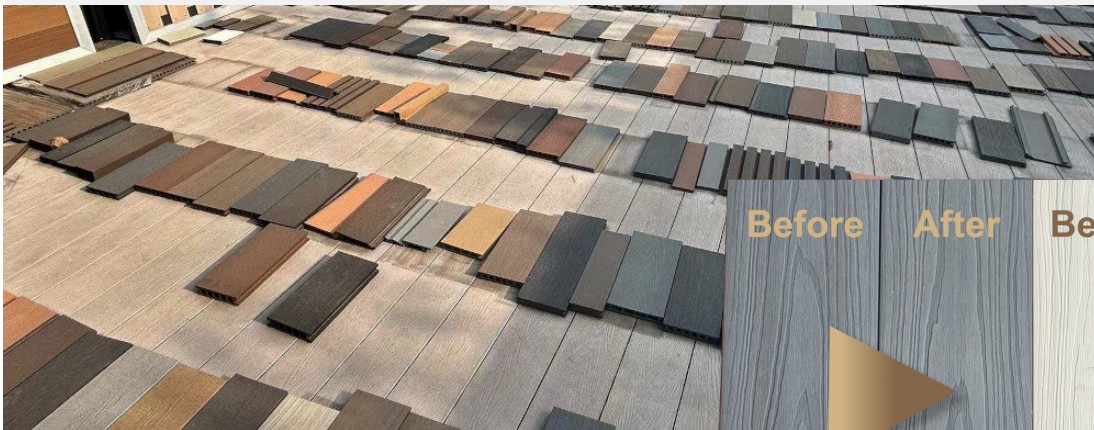

Warranty

The properties of our panels allow us to provide a warranty of up to 20 years for the facing boards against the appearance of cracks, stains and color changes.

We guarantee that products are resistant and shall conserve their resistance to colour changes related to exposure to light and to inclement weather, and shall not change colour more than 5 Delta E (Hunter) units.



Detailed information on warranty conditions is a separate document.

5 Δ E

Easy installation

The installation of cladding panels is very simple. By gradually placing the panels next to each other, you will achieve a very nice appearance of your house in the end.



Easy
installation

Panel CARLOS



teak

cedar

silver
gray

walnut

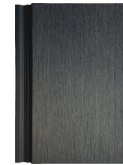

PA5919

PA5920

PA5921

PA5922

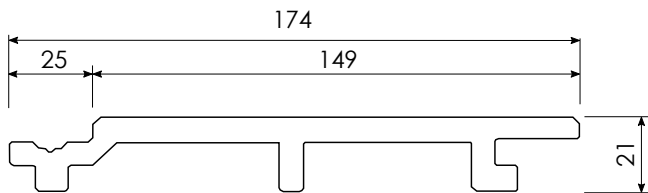

Usable surface per board	0,432 m ²
Mass per unit area	11,8 kg/m ²
Outer width	174 mm
Usable width	149 mm
Standard lenght	2 900 mm



panel corner universal
41 x 53 mm x 2,90 m

item PA5933 | Teak
item PA5934 | Walnut

item PA5935 | Cedar
item PA5936 | Silver Gray



panel underlay WPC black
40 x 30 mm x 2,90 m

item PA5932 | Black

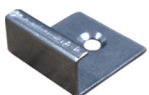

starting clip
24 x 28 x 4 mm

Product description:

	Nominal values
Type of product	Wood-plastic composite (WPC) cladding. The core of the wood-plastic composite consists of 60% wood and 40% high-density polyethylene (HDPE) fillers + additives. The core is covered with a coextruded plastic cap layer. The profile has got a tongue- and groove connection.
Manufacturer	GAUDIAHOME, s.r.o
Ratio wood/ HDPE	35 % Plastic, 60 % Wood fiber, 5 % Additives
Item No.	PA5919, PA5920, PA5921, PA5922
Item Name	PANEL CARLOS TEAK, PANEL CARLOS CEDAR, PANEL CARLOS SILVER GRAY, PANEL CARLOS WALNUT
Profiling/ shape	The technical drawing is visible in Figure 1
Profile width (mm)	174
Total thickness (mm)	21
<i>Thickness core</i>	6 - 7
<i>Thickness coextruded layer (cap)</i>	0.5
Density(g/m ³)	1.35
Color	Teak, Cedar Silver Gray, Walnut
Surface structure	
Lenght (mm)	2 900

Figure 1: Profile of the material

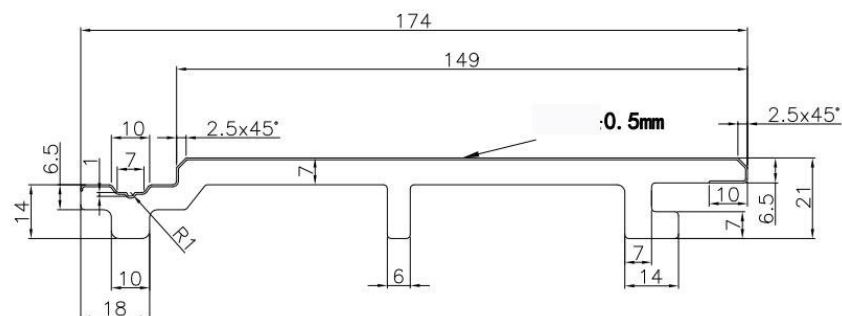

Test	Standard / Method	Value	Verdit
Physical Properties			
Moisture Content	EN15534 EN322	0.85%	
Mechanical Properties			
Falling Mass Impact Resistance	EN15534	Max Crack length(mm): No crack. Max Residual Indentation(mm): 0.13	Pass
Brinell Hardness	EN15534	83Mpa	
Resistance to Indentation	EN15534	Rate of elastic recovery: 73%	
Bond Strength	EN319	Average Bond Strength>1.78MPa No obvious abruption and damage after test	
Thermal Properties			
Coefficient of Linear Thermal Expansion	EN15534	$41.6 \times 10^{-6} K^{-1}$	$\leq 50 \times 10^{-6} K^{-1}$ Pass
Heat Build-up	EN15534	$\Delta T = -2.9^{\circ}C$	
Durability			
Resistance to Artificial Weathering	EN15534	No blistering, cracking or peeling observed	
Swelling and Water Absorption (28days immersion)	EN15534	Swelling: 0.89% Δ in thickness, 0.07% Δ in width, 0.07% Δ in length.	Swelling $\leq 4\%$ in thickness $\leq 0.8\%$ in width $\leq 0.4\%$ in length Pass
		Water absorption: Max $\leq 1.09\%$	Water absorption: Max $\leq 9\%$ Pass
Resistance to Boiling Water	EN15534	Mean: 0.95%	Mean $\leq 7\%$ Pass
		Max : 1%	Max. $\leq 9\%$ Pass
Mould Resistance	EN15534	Rating 0, no growth	
Fire			
Euroclass	EN13501	C	
Safety & Environment Protection			
Heavy Metal Content	EPA3051	Sb:ND, As:ND, Se:ND, Sn:ND	
Lead Content Test	EUNo.628/2015	Non Detected	
Pb, Cd, Hg, Cr6+	RoHS- IEC62321	Pb:ND, Cd:ND, Hg:ND, Cr6+:ND	

Panel BRUNO

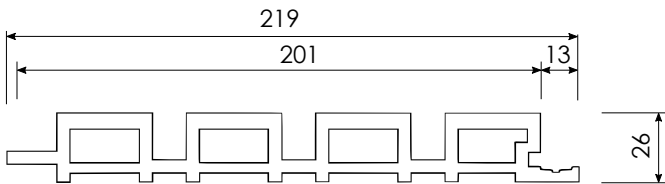
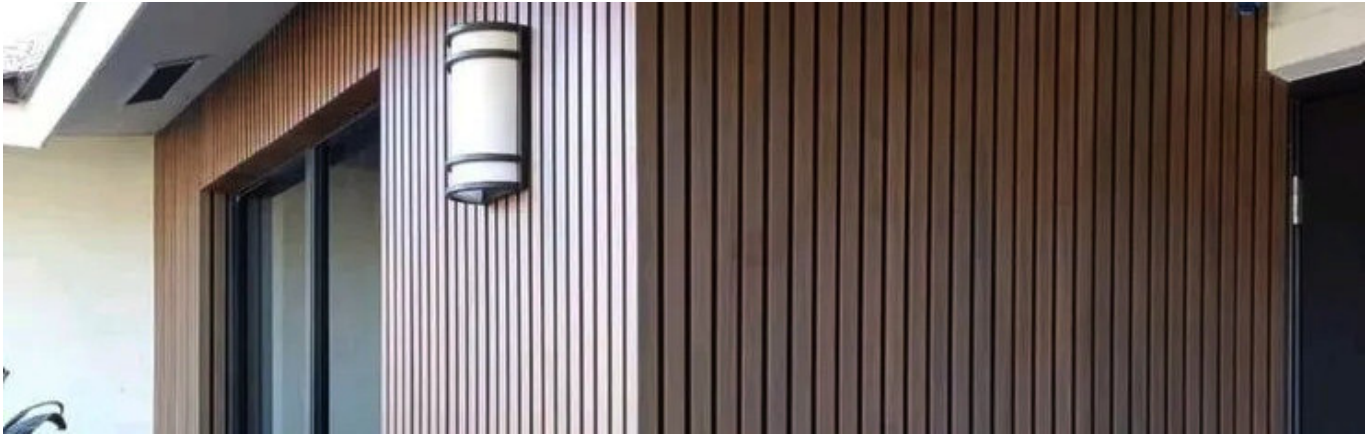

Usable surface per board	0,58 m ²
Mass per unit area	10,95 kg/m ²
Outer width	219 mm
Usable width	201 mm
Standard lenght	2 900 mm

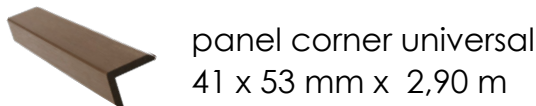

- item PA5933 | Teak
- item PA5934 | Walnut
- item PA5935 | Cedar
- item PA5936 | Silver Gray



- item PA5937 | Teak
- item PA5938 | Walnut
- item PA5939 | Cedar
- item PA5940 | Silver Gray



- item PA5941 | Teak
- item PA5942 | Walnut
- item PA5943 | Cedar
- item PA5944 | Silver Gray

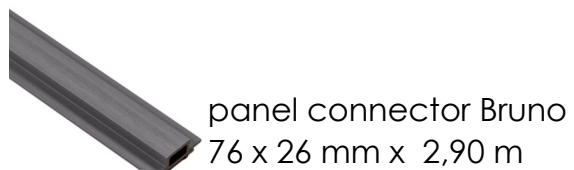

- item PA5949 | Teak
- item PA5950 | Walnut
- item PA5951 | Cedar
- item PA5952 | Silver Gray

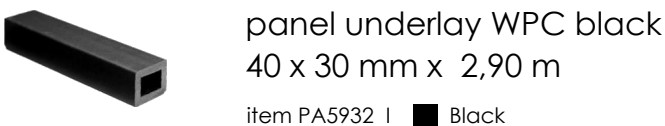

Product description:

Nominal values	
Type of product	Wood-plastic composite (WPC) cladding. The core of the wood-plastic composite consists of 60% wood and 40% high-density polyethylene (HDPE) fillers + additives. The core is covered on all sides with a coextruded plastic cap layer. The profile has got a tongue- and groove connection.
Manufacturer	GAUDIAHOME, s.r.o
Ratio wood/ HDPE	35 % Plastic, 60 % Wood fiber, 5 % Additives
Item No.	PA5927, PA5928, PA5929, PA5930
Item Name	PANEL BRUNO TEAK/CHARCOAL, PANEL BRUNO CEDAR/CHARCOAL, PANEL BRUNO SILVER GRAY/CHARCOAL, PANEL BRUNO WALNUT/CHARCOAL
Profiling/ shape	The technical drawing is visible in Figure 1
Profile width (mm)	219
Total thickness (mm)	26
<i>Thickness core</i>	
<i>Thickness coextruded layer (cap)</i>	0.5
Density(g/m ³)	1.35
Color	Teak, Cedar, Silver Gray, Walnut
Surface structure	
Length (mm)	2 900

Figure 1: Profile of the material

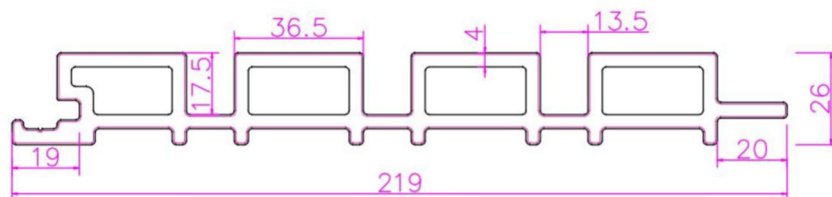

Test	Standard / Method	Value	Verdit
Physical Properties			
Moisture Content	EN15534 EN322	0.85%	
Mechanical Properties			
Falling Mass Impact Resistance	EN15534	Max Crack length(mm): No crack. Max Residual Indentation(mm): 0.13	Pass
Brinell Hardness	EN15534	83Mpa	
Resistance to Indentation	EN15534	Rate of elastic recovery: 73%	
Bond Strength	EN319	Average Bond Strength>1.78MPa No obvious abruption and damage after test	
Thermal Properties			
Coefficient of Linear Thermal Expansion	EN15534	$41.6 \times 10^{-6} K^{-1}$	$\leq 50 \times 10^{-6} K^{-1}$ Pass
Heat Build-up	EN15534	$\Delta T = -2.9^{\circ}C$	
Durability			
Resistance to Artificial Weathering	EN15534	No blistering, cracking or peeling observed	
Swelling and Water Absorption (28days immersion)	EN15534	Swelling: 0.89%/in thickness, 0.07%/in width, 0.07%/in length.	Swelling $\leq 4\%$ in thickness $\leq 0.8\%$ in width $\leq 0.4\%$ in length Pass
		Water absorption: Max $\leq 1.09\%$	Water absorption: Max. $\leq 9\%$ Pass
Resistance to Boiling Water	EN15534	Mean: 0.95%	Mean $\leq 7\%$ Pass
		Max : 1%	Max. $\leq 9\%$ Pass
Mould Resistance	EN15534	Rating 0, no growth	
Fire			
Euroclass	EN13501	C	
Safety & Environment Protection			
Heavy Metal Content	EPA3051	Sb:ND, As:ND, Se:ND, Sn:ND	
Lead Content Test	EUNo.628/2015	Non Detected	
Pb, Cd, Hg, Cr6+	RoHS- IEC62321	Pb:ND, Cd:ND, Hg:ND, Cr6+:ND	

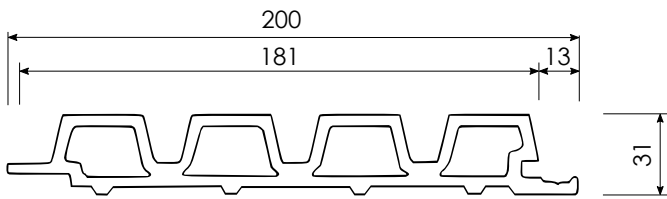
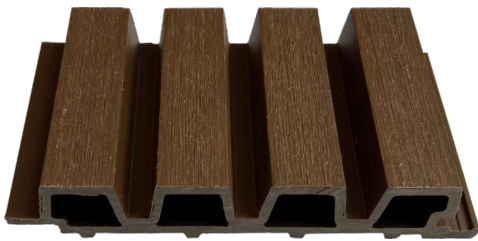

Usable surface per board	0,524 m ²
Mass per unit area	14,9 kg/m ²
Outer width	200 mm
Usable width	181 mm
Standard lenght	2 900 mm

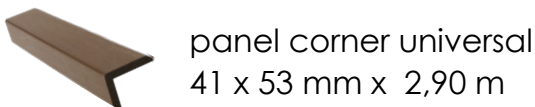

- item PA5933 | ■ Teak item PA5935 | ■ Cedar
- item PA5934 | ■ Walnut item PA5936 | ■ Silver Gray



- item PA5945 | ■ Teak item PA5947 | ■ Cedar
- item PA5946 | ■ Walnut item PA5948 | ■ Silver Gray



- item PA5941 | ■ Teak item PA5943 | ■ Cedar
- item PA5942 | ■ Walnut item PA5944 | ■ Silver Gray

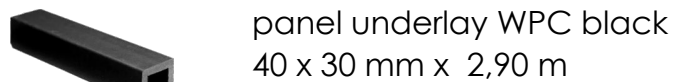

- item PA5932 | ■ Black

Product description:

Nominal values	
Type of product	Wood-plastic composite (WPC) cladding. The core of the wood-plastic composite consists of 60% wood and 40% high-density polyethylene (HDPE) fillers + additives. The core is covered on all sides with a coextruded plastic cap layer. The profile has got a tongue- and groove connection.
Manufacturer	GAUDIAHOME, s.r.o
Ratio wood/ HDPE	35 % Plastic, 60 % Wood fiber, 5 % Additives
Item No.	PA5923, PA5924, PA5925, PA5926
Item Name	PANEL LEO TEAK, PANEL LEO CEDAR, PANEL LEO SILVER GRAY, PANEL LEO WALNUT
Profiling/ shape	The technical drawing is visible in Figure 1
Profile width (mm)	200
Total thickness (mm)	31
<i>Thickness core</i>	4-4.5
<i>Thickness coextruded layer (cap)</i>	1
Density(g/m ³)	1.35
Color	Teak, Cedar, Silver Gray, Walnut
Surface structure	
Lenght (mm)	2 900

Figure 1: Profile of the material

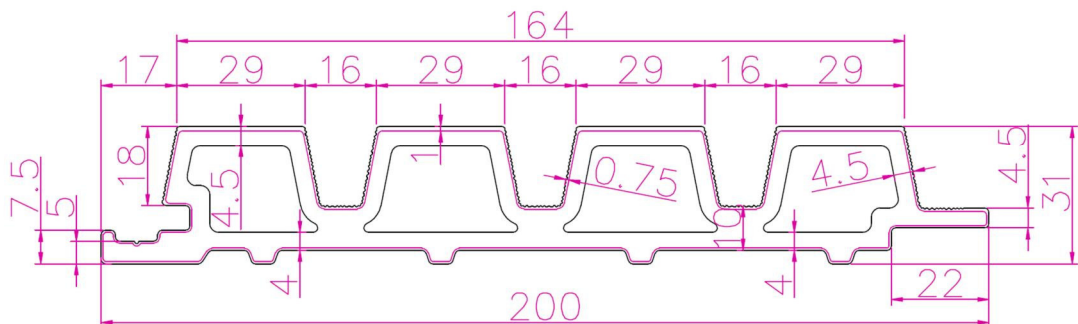

Test	Standard / Method	Value	Verdit
Physical Properties			
Moisture Content	EN15534 EN322	0.85%	
Mechanical Properties			
Falling Mass Impact Resistance	EN15534	Max Crack length(mm): No crack. Max Residual Indentation(mm): 0.13	Pass
Brinell Hardness	EN15534	83Mpa	
Resistance to Indentation	EN15534	Rate of elastic recovery: 73%	
Bond Strength	EN319	Average Bond Strength>1.78MPa No obvious abruption and damage after test	
Thermal Properties			
Coefficient of Linear Thermal Expansion	EN15534	$41.6 \times 10^{-6} K^{-1}$	$\leq 50 \times 10^{-6} K^{-1}$ Pass
Heat Build-up	EN15534	$\Delta T = -2.9^{\circ}C$	
Durability			
Resistance to Artificial Weathering	EN15534	No blistering, cracking or peeling observed	
Swelling and Water Absorption (28days immersion)	EN15534	Swelling: 0.89% in thickness, 0.07% in width, 0.07% in length.	Swelling $\leq 4\%$ in thickness $\leq 0.8\%$ in width $\leq 0.4\%$ in length Pass
		Water absorption: Max $\leq 1.09\%$	Water absorption: Max. $\leq 9\%$ Pass
Resistance to Boiling Water	EN15534	Mean: 0.95%	Mean $\leq 7\%$ Pass
		Max. : 1%	Max. $\leq 9\%$ Pass
Mould Resistance	EN15534	Rating 0, no growth	
Fire			
Euroclass	EN13501	C	
Safety & Environment Protection			
Heavy Metal Content	EPA3051	Sb:ND, As:ND, Se:ND, Sn:ND	
Lead Content Test	EUNo.628/2015	Non Detected	
Pb, Cd, Hg, Cr6+	RoHs- IEC62321	Pb:ND, Cd:ND, Hg:ND, Cr6+:ND	

Assembly - basic attachment

Panel CARLOS

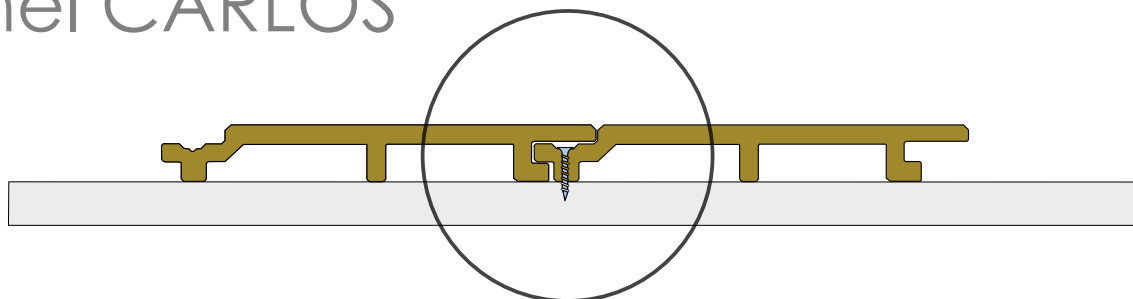

Panel BRUNO

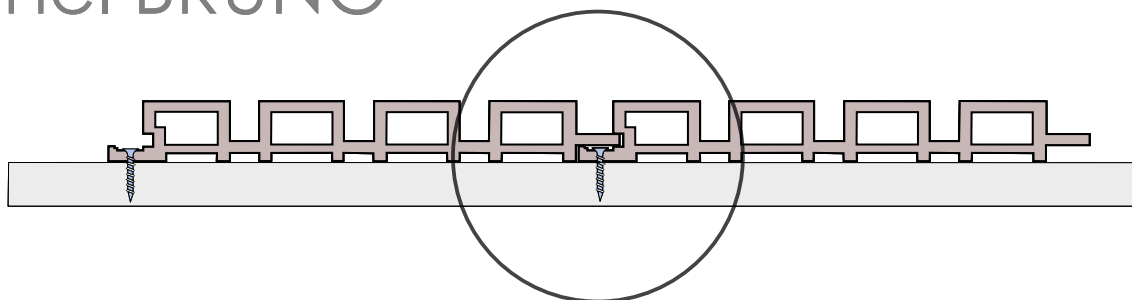

Panel LEO

