

Assembly instruction

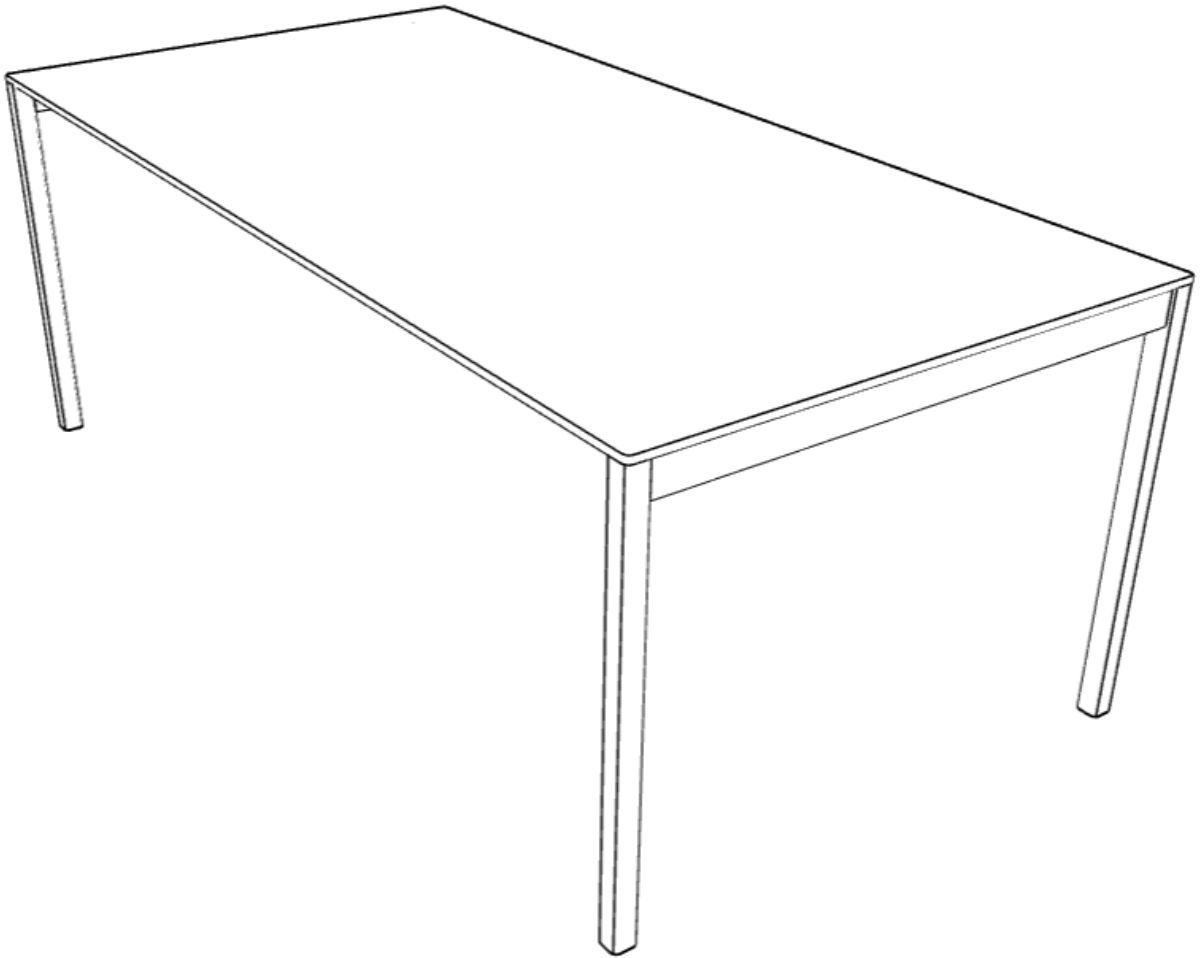

Complexity



Time



20min

Instruments



People

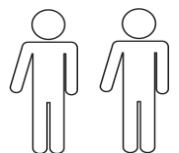

PARTS PROVIDED

A

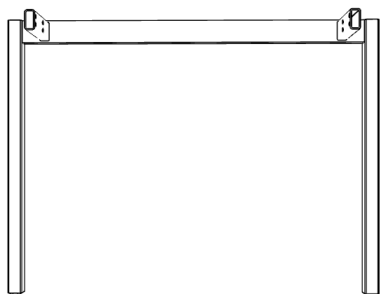

2X

B

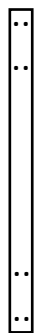

2X

C

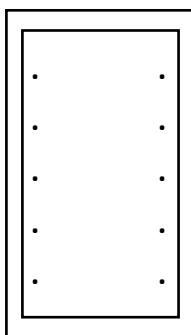

1X

D

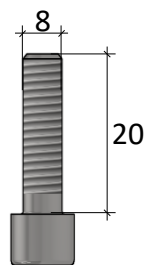

16X

E

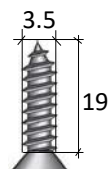

10X

F



16X

STEP 1

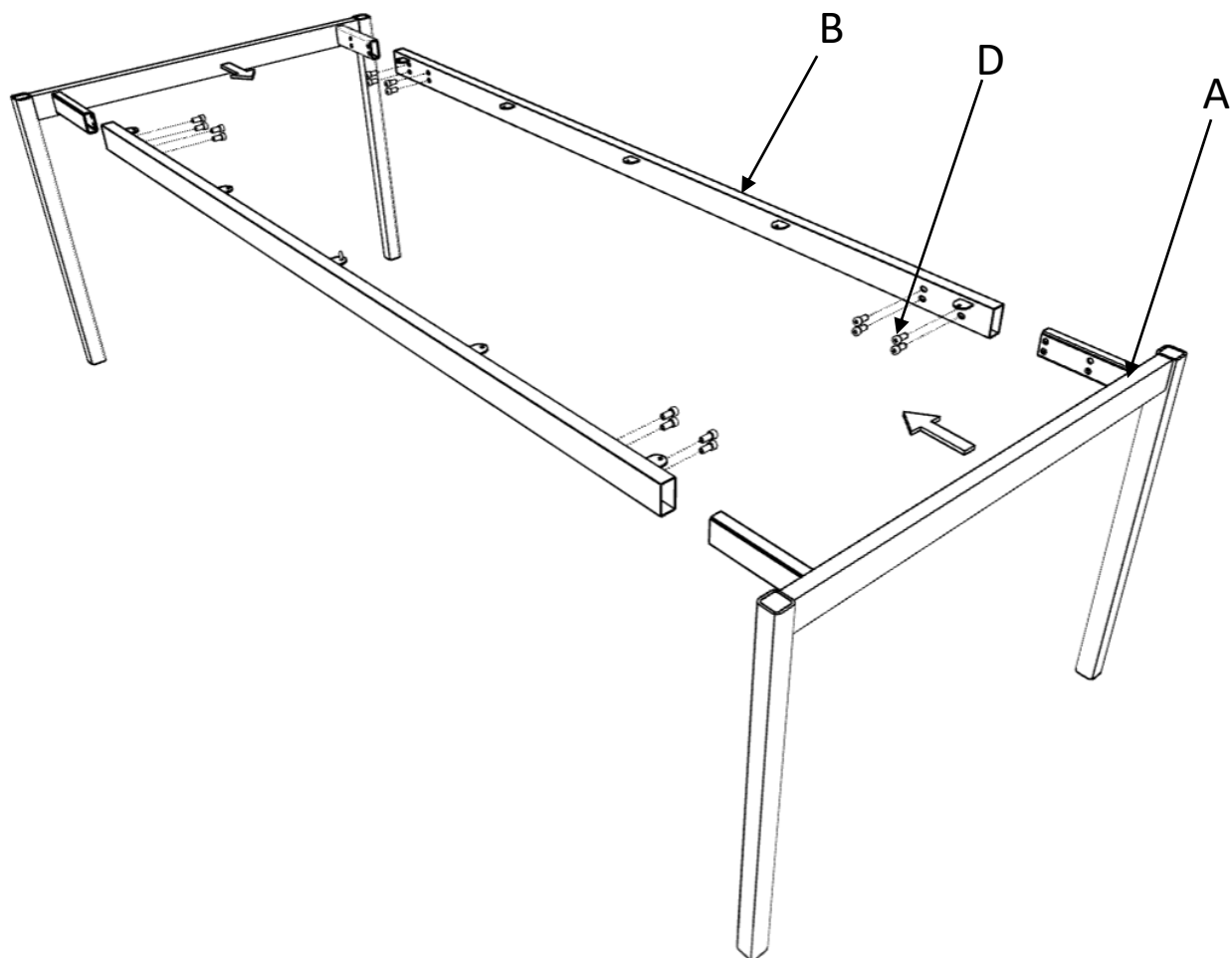

STEP 2

